

Form 2/3DV

Aszimmetrikus K varrat

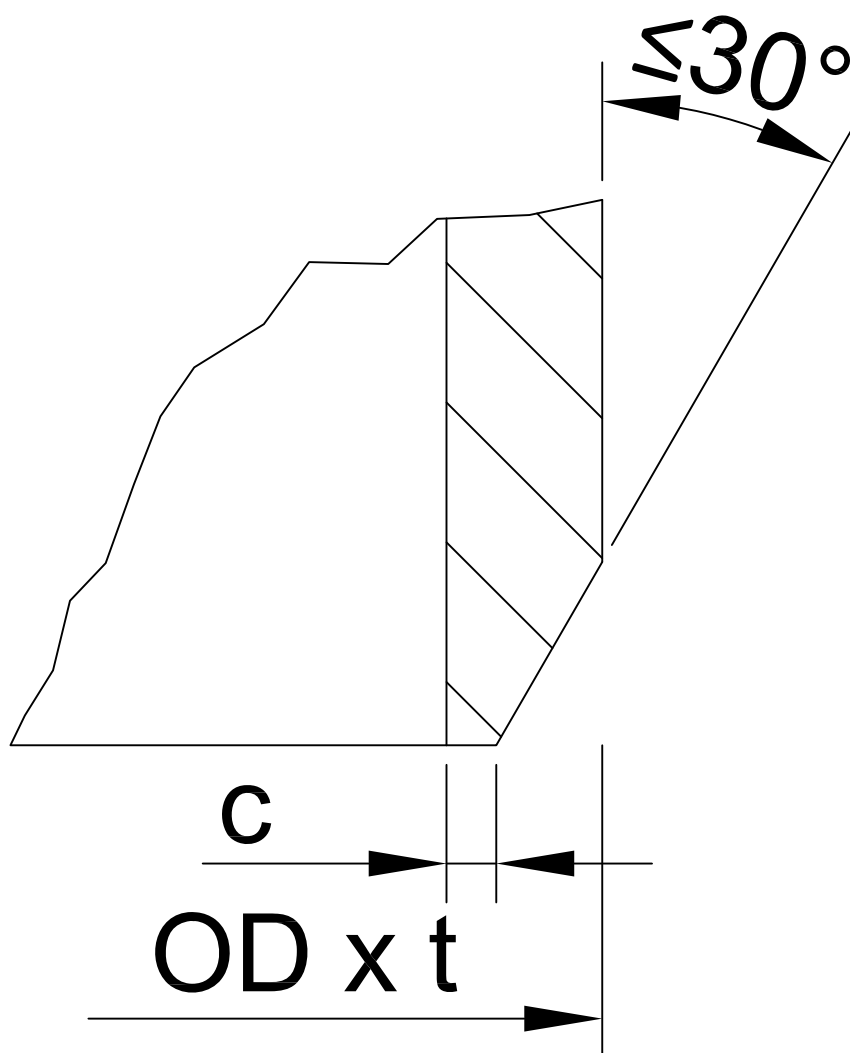

Form BA
Átmenet kívül

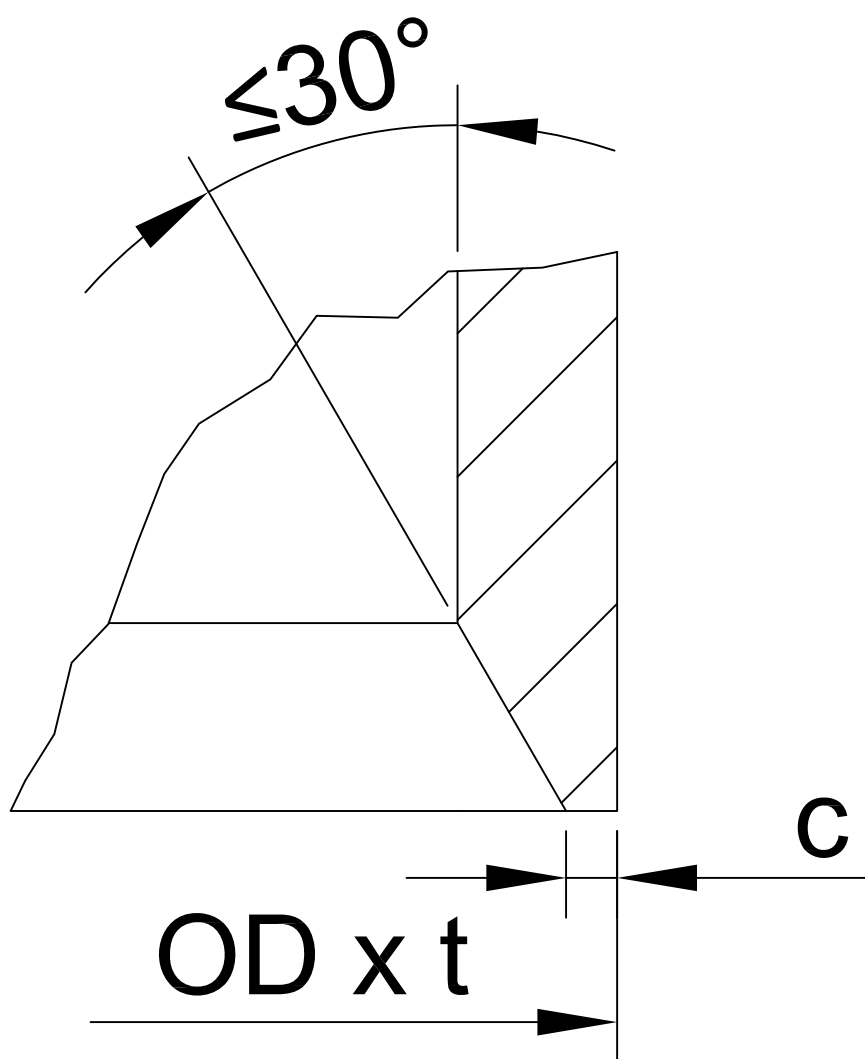

Form B1
Átmenet belül

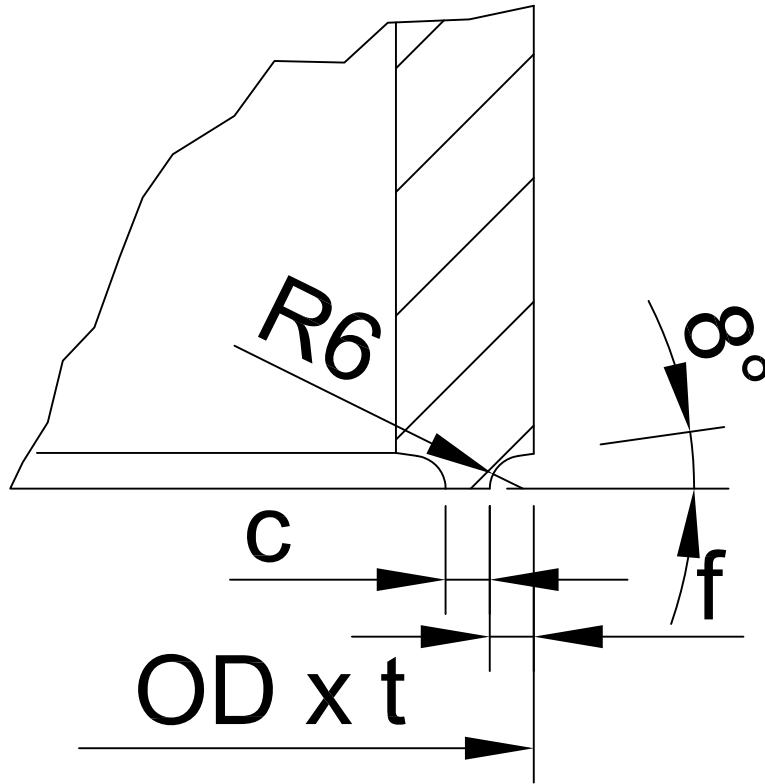

Form DU

Dupla U varrat

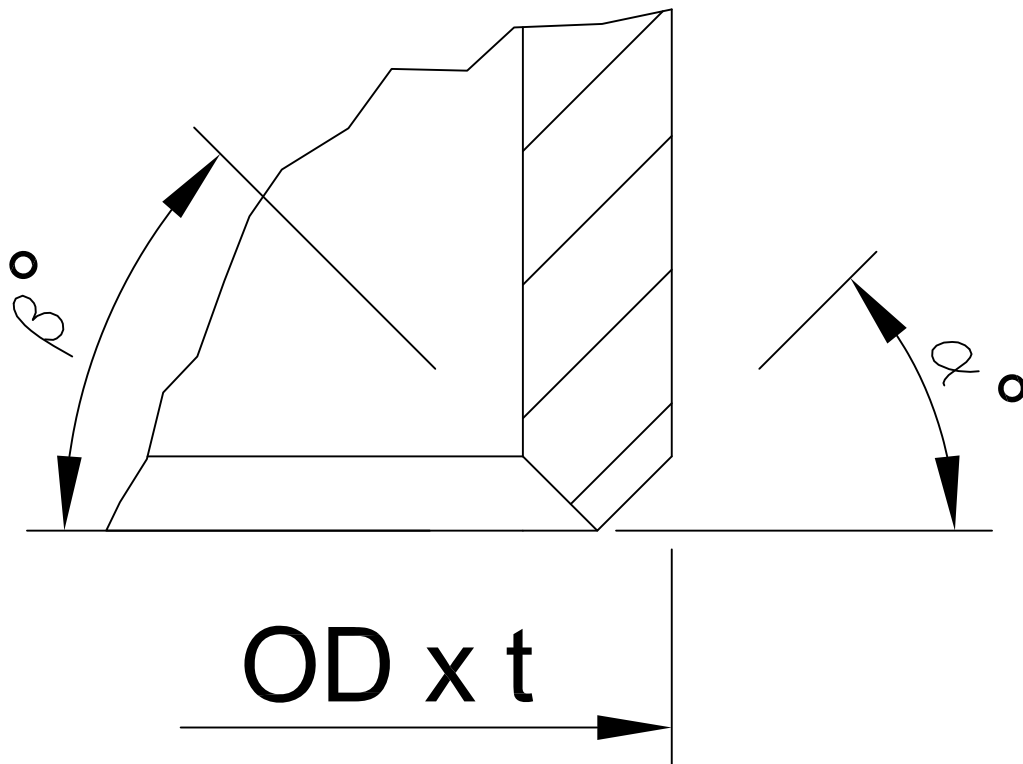

Form DV
Dupla V varrat

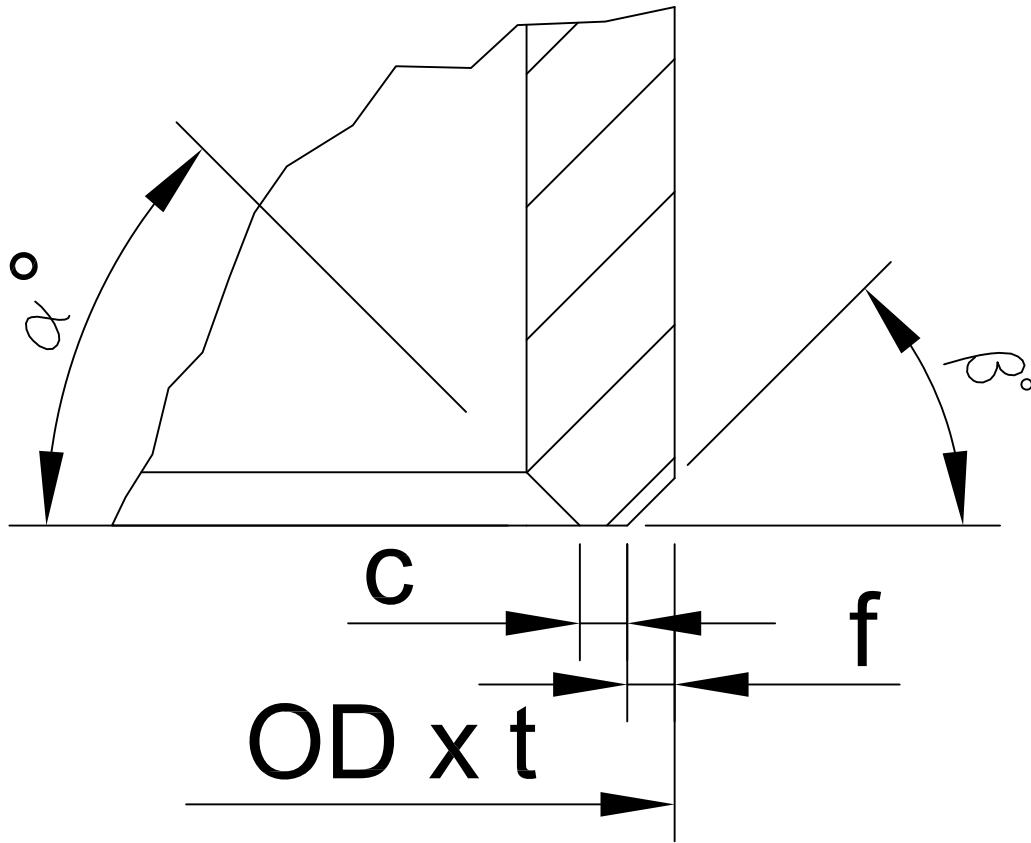

Form DY

Dupla Y varrat

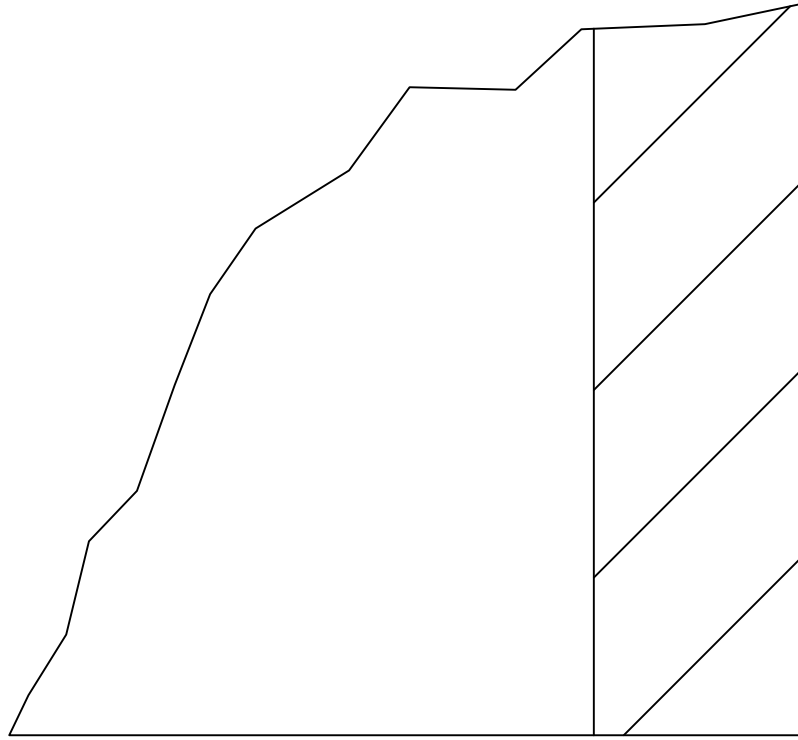

OD x t

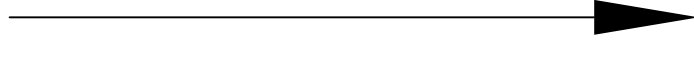

Form I
I-varrat

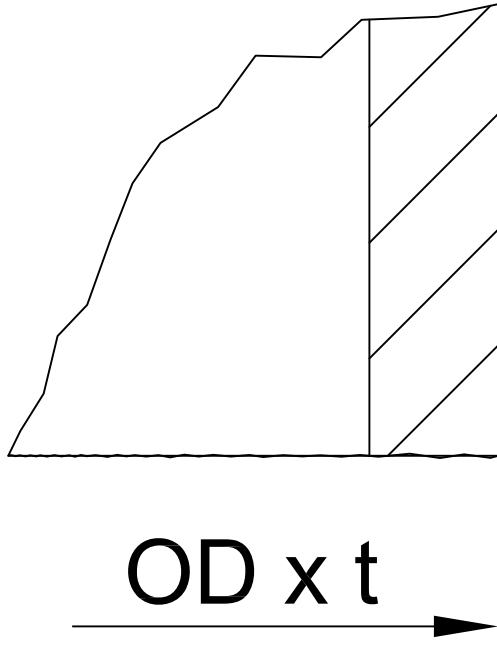

Form R

Nyers

Megmunkálatlan

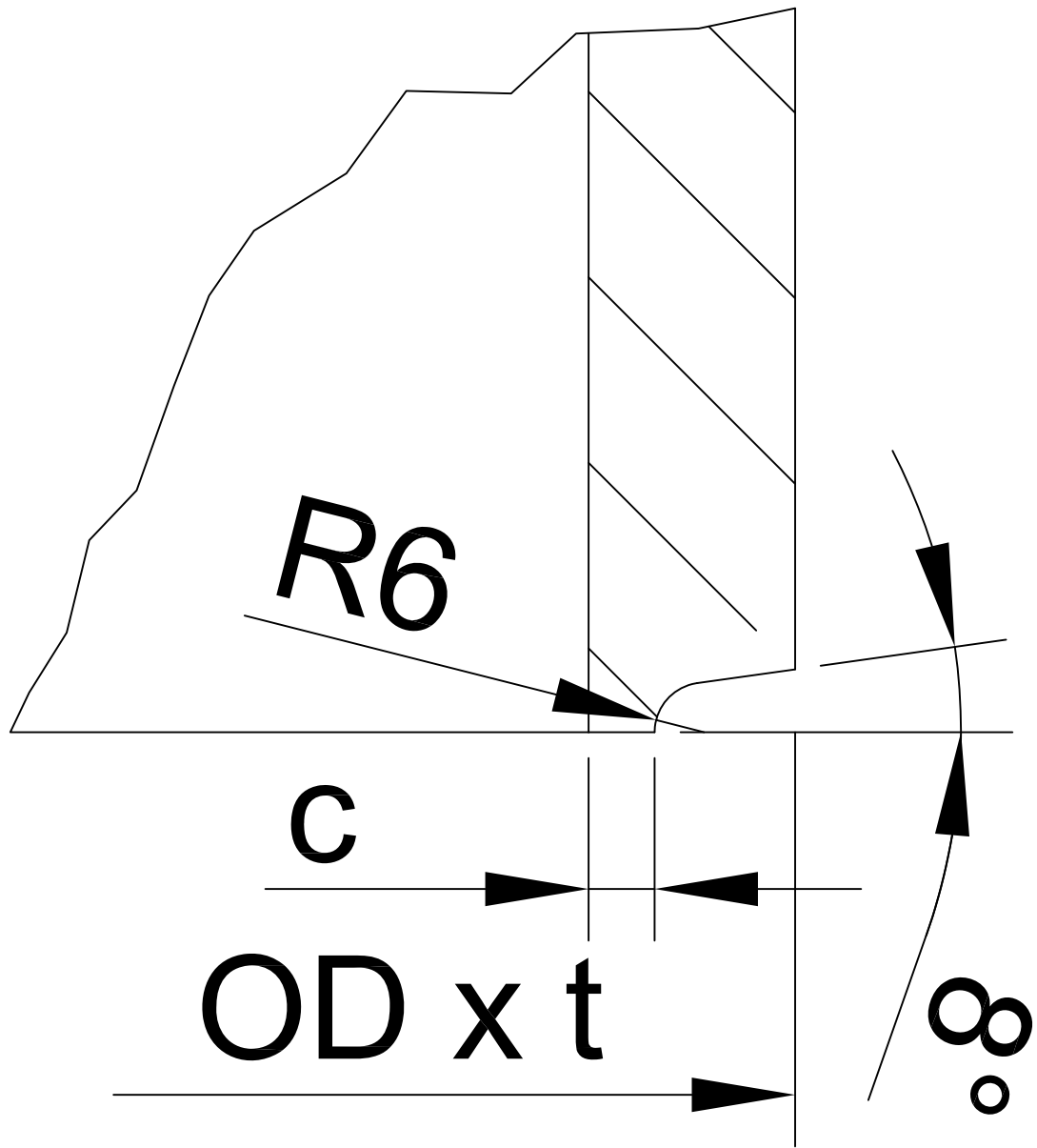

Form U
U varrat

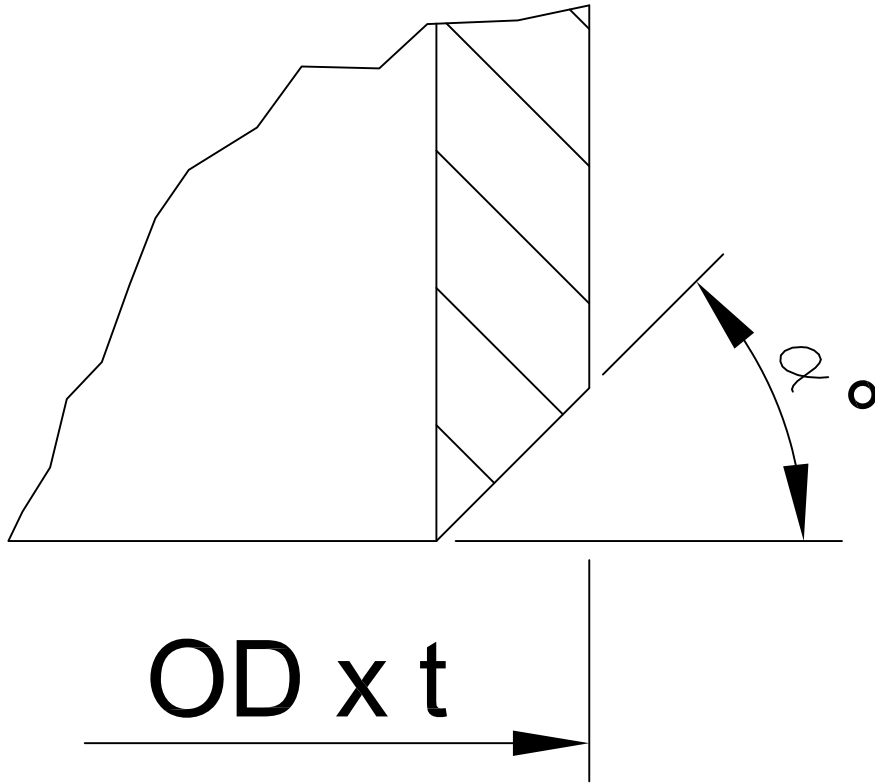

Form VA

Külső V varrat

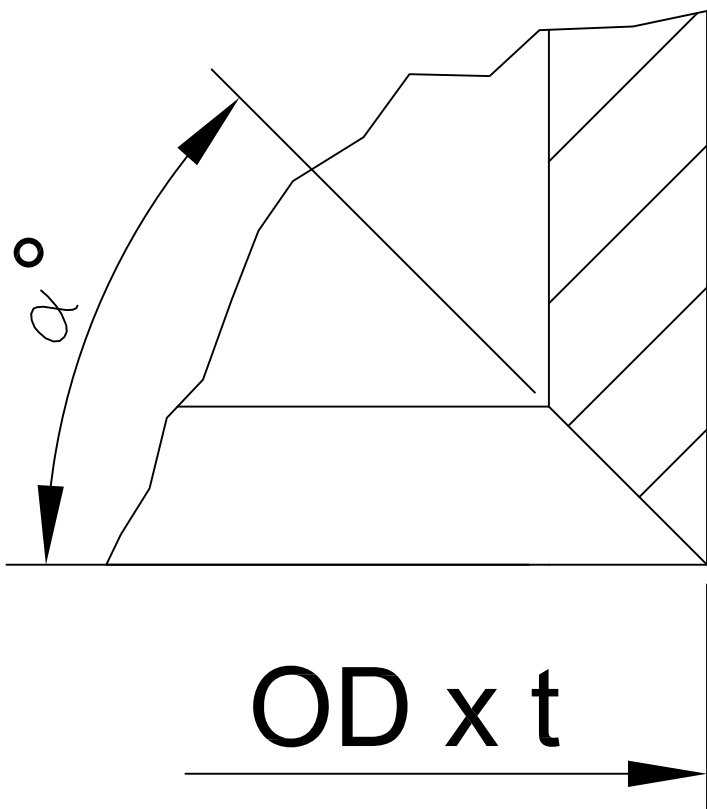

Form VI

Belső V varrat

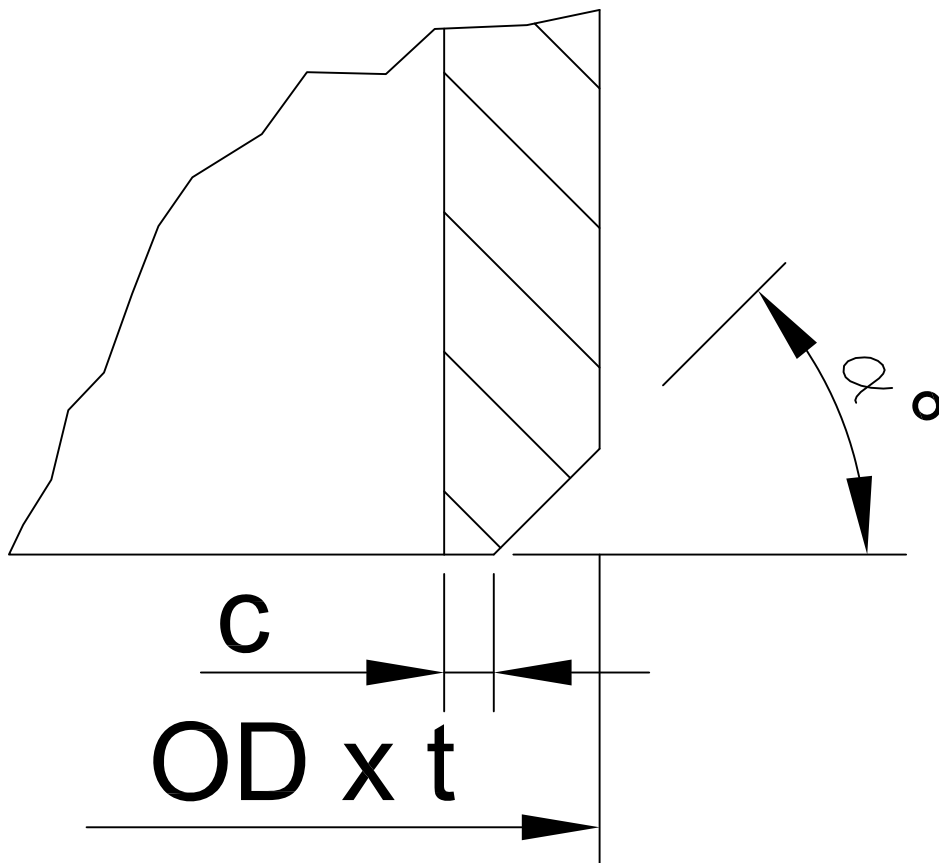

Form YA

Külső Y varrat

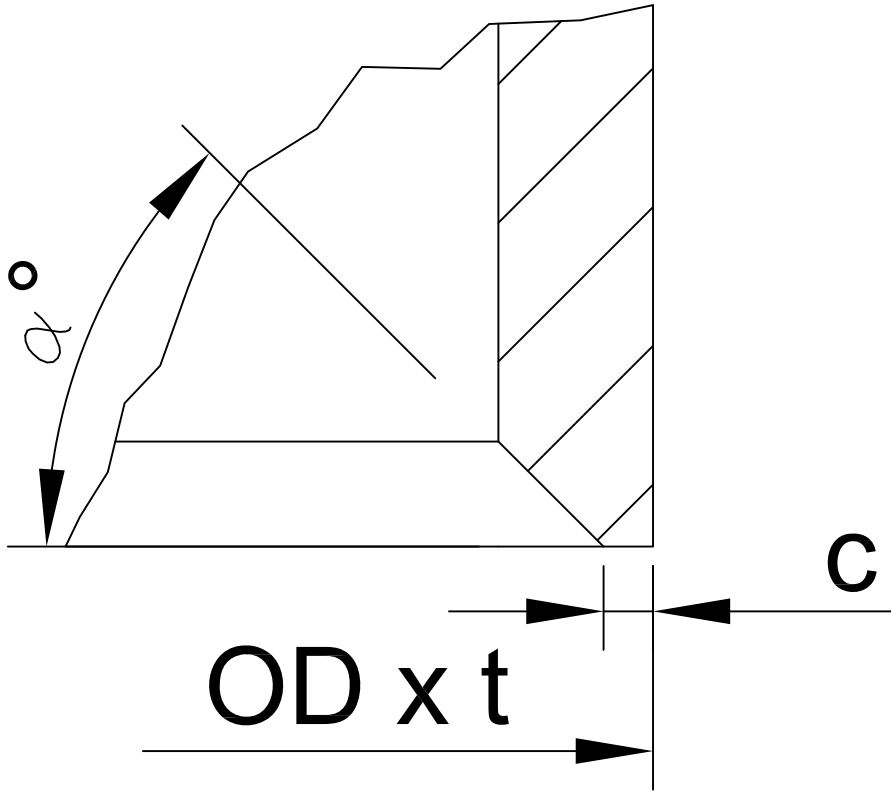

Form YI

Belső Y varrat